

DUCTILE IRON FLANGED PIPE

APPLICATION

Most commonly used in rigid pipe systems in well supported above ground pipe installations. Ductile iron Flanged pipe is particularly suited for water filtration plants, sewage disposal plants, wastewater treatment plants, pumping and lift stations, and industrial process plant applications.



- The use of flanged joints in underground applications is generally not recommended. Piping should be properly anchored, supported, and restrained to prevent damage to flanges. Flanged faces should bear uniformly on the gasket. Bolts should be tightened in a progressively criss-crossed pattern, such as tightening the bottom remaining bolts in a similar fashion. This criss-cross pattern should be repeated until the appropriate torque is applied. Care should be taken NOT to overtighten the bolts. Overtightening the bolts or attempting to close excess "gaps" between flanges will cause damage to the flange and pipe.

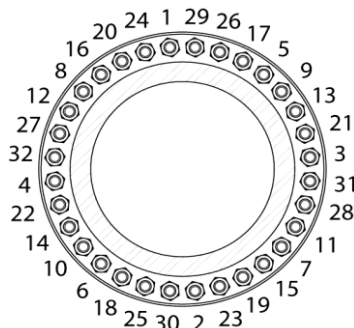

DUCTILE IRON FLANGED PIPE

- Ductile Iron Flanged Pipe is manufactured in accordance **ANSI/AWWA C115/A21.15**. See attached TABLE 1 for technical data.

- Ductile iron pipe conforms to **ANSI/AWWA C151/A21.51**. Pipe shall be minimum Class 53. C&B uses ductile iron pipe made in the USA.

Pipe Class submitted is noted below.

CL 53 CL54 CL55 CL56

- Flanges are made of ductile iron and are drilled in accordance with **ANSI B16.1** CL 125 rated for 250 psi. ANSI CL 250 drilled flanges are available upon request. Flanges submitted are noted below. See attached TABLE 2 for technical data.

CL125 CL250

Flanges are manufactured from import sources. As an option to the customer, USA manufactured flanges may be selected. Flanges submitted are manufactured from
 IMPORT USA

- C&B wall collars are industry standard and are made of ductile iron (ASTM A536-70:50:05) and are welded continuously both sides of the collar with NI-55 weld rod. The collars are rated for 250 psi thrust load. See DI WALL PIPE submittal for technical data.

- C&B standard lining is double thickness cement mortar and bituminous seal coat in accordance with **ANSI/AWWA C104/A21.4**. C&B offers special linings when required by the project per pipe system. Linings submitted are noted below.

CEM PROTECTO 401 CBGL911 GLASS

- C&B standard exterior coating is bituminous asphalt in accordance with **ANSI/AWWA C151/A21.51**. If the pipe is required to be shop coated for temporary jobsite protection, C&B applies Sherwin Williams Macropoxy 646 epoxy @ 3-5 mils dft. Tech Data Sheet included.

30"-64" Flanged Pipe fabricated by C&B Piping, Inc will be furnished with FLANGE-TYTE Gaskets. This gasket is uniquely designed to perform best for use with ductile iron flanges.

If purchased from C&B, we can furnish 4"-24" FLANGE-TYTE Gaskets with your order at additional cost.

	Approximate Bolt Torque (ft-lb)																	
	04"	06"	08"	10"	12"	14"	16"	18"	20"	24"	30"	36"	42"	48"	54"	60"	64"	
150 PSI ---->																		550 600 600
250 PSI ---->	90	90	90	90	90	110	110	120	120	130	140	160	160	585	625			
350 PSI ---->	110	110	110	130	130	150	160	180	200	220								

DUCTILE IRON FLANGED PIPE

REV 2016

FLANGED PIPE

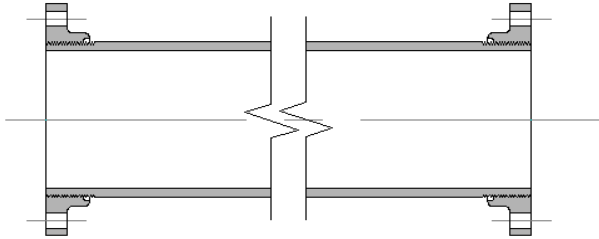

THREADED COMPANION FLANGE

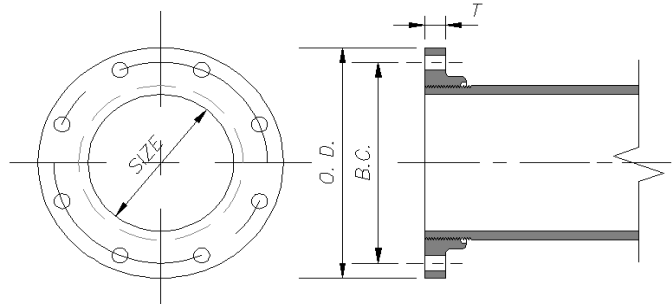

SIZE (IN.)	PRESSURE RATING PSI	OUTSIDE DIAM. (IN.)	MIN WALL THICKNESS (CL53) (IN)	WEIGHT IN POUNDS			
				MAX LENGTH (FT-IN)	W/O FLGS PER/FT	WITH FLGS PER/EA	
03"	250	3.96	0.31	17' 6"	7	10.9	205
04"	250 †	4.80	0.32	19' 6"	13	13.8	295
06"	250 †	6.90	0.34	19' 6"	17	21.4	451
08"	250 †	9.05	0.36	19' 6"	28	30.1	643
10"	250 †	11.10	0.38	19' 6"	38	39.2	840
12"	250 †	13.20	0.40	19' 6"	58	49.2	1075
14"	250 †	15.30	0.42	19' 6"	72	60.1	1316
16"	250 †	17.40	0.43	19' 6"	80	70.1	1527
18"	250 †	19.50	0.44	19' 6"	90	80.6	1752
20"	250 †	21.60	0.45	19' 6"	115	91.5	2014
24"	250 †	25.80	0.47	19' 6"	160	114.4	2551
30"	250	32.00	0.51	17' 6"	240	154.4	3182
36"	250	38.30	0.58	17' 6"	350	210.3	4380
42"	250	44.50	0.65	17' 6"	500	274.0	5795
48"	250	50.80	0.72	19' 0"	625	346.6	7835
54"	250	57.56	0.81	19' 0"	670	441.9	9736
60"	250	61.61	0.83 #	19' 0"	1035	485.0	11285
64"	250	65.67	0.87 #	19' 0"	1510	542.0	13318

TABLE 1

† This size may be rated at 350 psi if FLANGE-TYTE gaskets are utilized during installation.

Wall thickness corresponds to CL350 or 60" and 64" diameters

SIZE (IN.)	DIMENSIONS IN INCHES				# BOLTS
	OD	BC	T	BOLT DIA & LENGTH	
03"	7.50	6.00	0.75 ± .12	5/8 X 2 1/2	4
04"	9.00	7.50	0.94 ± .12	5/8 X 3	8
06"	11.00	9.50	1.00 ± .12	3/4 x 3 1/2	8
08"	13.50	11.75	1.12 ± .12	3/4 x 3 1/2	8
10"	16.00	14.25	1.19 ± .12	7/8 x 4	12
12"	19.00	17.00	1.25 ± .12	7/8 x 4	12
14"	21.00	18.75	1.38 ± .19	1 x 4 1/2	12
16"	23.50	21.25	1.44 ± .19	1 x 4 1/2	16
18"	25.00	22.75	1.56 ± .19	1 1/8 x 5	16
20"	27.50	25.00	1.69 ± .19	1 1/8 x 5	20
24"	32.00	29.50	1.88 ± .19	1 1/4 x 5 1/2	20
30"	38.75	36.00	2.12 ± .25	1 1/4 x 6 1/2	28
36"	46.00	42.75	2.38 ± .25	1 1/2 x 7	32
42"	53.00	49.50	2.62 ± .25	1 1/2 x 7 1/2	36
48"	59.50	56.00	2.75 ± .25	1 1/2 x 8	44
54"	66.25	62.75	3.00 ± .25	1 3/4 x 8 1/2	44
60"	73.00	69.25	3.12 ± .25	1 3/4 x 9	52
64"	80.00	76.00	3.38 ± .25	1 3/4 x 9	52

TABLE 2

- ☐ Flanges are plain faces without projection or raised face and are furnished smooth or with shallow serrations.
- ☐ Flanges may be back or spot faced for compliance with flange thickness tolerances.
- ☐ Pipe face-to-face dimensions conform to a tolerance of ±0.12 in. for FLG x FLG, ±0.25 in for FLG X PE. Some spools may be available at "exact" length if specified in advance. Additional charges will apply
- ☐ The bolt circle and bolt holes match those of ANSI/AWWA C115/A21.15 and CL125 flanges shown in ANSI B16.1. These flanges do not match the CL250 flange shown in ANSI B16.1 and cannot be joined with CL250 B16.1 fittings.

DUCTILE IRON FLANGED PIPE

REV 2016

FLANGED PIPE MIN LENGTHS

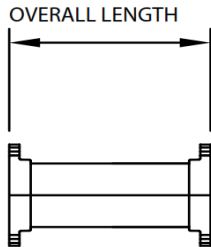

FLANGE - FLANGE

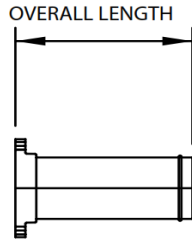

FLANGE - PLAIN END (TR or HP)

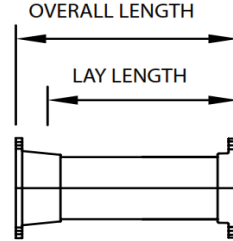

MJ - FLANGE

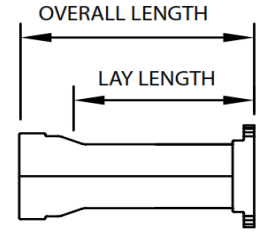

TR FLEX - FLANGE

SIZE (IN.)	F-F	F-PE	F-TRP	TMJ-FLG		TMJ-TMJ		TR BELL-F	
	OA	OA	OA	OA	LL	OA	LL	OA	LL
03"	4.25	2.75	X	6.50	4.00	9.00	4.00	X	X
04"	4.50	3.00	10.50	6.50	4.00	9.00	4.00	10.25	5.50
06"	5.00	3.25	11.50	7.00	4.50	9.50	4.50	11.00	5.75
08"	5.50	3.50	12.50	7.50	5.00	10.00	5.00	12.00	6.25
10"	5.75	3.75	13.00	7.75	5.25	10.25	5.25	12.25	6.25
12"	5.75	3.75	13.75	8.25	5.75	10.75	5.75	12.75	6.50
14"	5.75	3.75	15.50	9.75	6.25	13.50	6.50	15.00	7.25
16"	5.75	3.75	15.75	10.00	6.50	14.00	7.00	15.00	7.00
18"	6.00	3.75	16.50	10.25	6.75	14.50	7.50	15.25	7.00
20"	6.25	4.00	17.00	10.75	7.25	15.00	8.00	15.75	7.50
24"	6.75	4.25	18.00	11.25	7.75	15.50	8.50	16.25	7.50
30"	8.50	5.00	20.75	13.75	9.75	18.75	10.75	18.50	8.25
36"	9.50	5.50	22.50	14.75	10.75	20.00	12.00	19.75	9.00
42"	10.50	6.00	20.25	15.75	11.75	21.00	13.00	19.75	10.25
48"	10.75	6.25	21.00	16.00	12.00	21.00	13.00	20.25	12.25
54"	12.00	6.75	20.75	X	X	X	X	21.50	12.75
60"	12.50	7.00	22.50	X	X	X	X	21.75	11.75
64"	13.00	7.25	23.25	X	X	X	X	23.00	12.50

TABLE 3

For additional configurations not shown, please contact C&B Piping, Inc.
 For RGRV x RGRV pipe, the min length for 3" & 4" is 4" OA, and 6"-36" is 0' 6" OA